

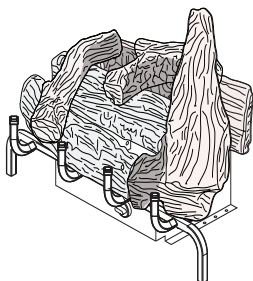

UNVENTED (VENT-FREE) GAS LOG HEATER
OWNER'S OPERATION AND INSTALLATION MANUAL



NATIONAL
FIREPLACE
INSTITUTE



CERTIFIED
www.nficertified.org

We recommend that our gas hearth products be installed and serviced by professionals who are certified in the U.S. by the National Fireplace Institute® (NFI) as NFI Gas Specialists.

18" AND 24" VARIABLE MANUAL CONTROL MODELS
HD18NB, HD18PB, HD24NB AND HD24PB
Also Design-Certified As Vented Decorative Appliances

⚠ WARNING: If the information in this manual is not followed exactly, a fire or explosion may result causing property damage, personal injury or loss of life.

- Do not store or use gasoline or other flammable vapors and liquids in the vicinity of this or any other appliance.
- **WHAT TO DO IF YOU SMELL GAS**
 - Do not try to light any appliance.
 - Do not touch any electrical switch; do not use any phone in your building.
 - Immediately call your gas supplier from a neighbor's phone. Follow the gas supplier's instructions.
 - If you cannot reach your gas supplier, call the fire department.
- Installation and service must be performed by a qualified installer, service agency or the gas supplier.

INSTALLER: Leave this manual with the appliance.
CONSUMER: Retain this manual for future reference.

TABLE OF CONTENTS

Safety	2	Troubleshooting	20
Product Identification	5	Parts	24
Local Codes	5	Specifications	26
Unpacking	5	Replacement Parts	26
Product Features	5	Technical Service	26
Air For Combustion and Ventilation	6	Service Hints	26
Installation	8	Accessories	26
Operation	17	Notes	27
Inspecting Burners	18	Warranty	Back Cover
Cleaning and Maintenance	19		

SAFETY

⚠ WARNING: Improper installation, adjustment, alteration, service or maintenance can cause injury or property damage. Refer to this manual for correct installation and operational procedures. For assistance or additional information consult a qualified installer, service agency or the gas supplier.

⚠ WARNING: This appliance is for installation only in a solid-fuel burning masonry or UL127 factory-built fireplace or in a listed ventless firebox enclosure. It is design-certified for these installations in accordance with ANSI Z21.11.2. Exception: Do not install this appliance in a factory-built fireplace that includes instructions stating it has not been tested or should not be used with unvented gas logs.

⚠ WARNING: This is an unvented gas-fired heater. It uses air (oxygen) from the room in which it is installed. Provisions for adequate combustion and ventilation air must be provided. Refer to *Air for Combustion and Ventilation* section on page 6 of this manual.

This appliance may be installed in an aftermarket,* permanently located, manufactured (mobile) home, where not prohibited by local codes. This appliance is only for use with the type of gas indicated on the rating plate. This appliance is not convertible for use with other gases.

* Aftermarket: Completion of sale, not for purpose of resale, from the manufacturer

SAFETY
Continued

⚠ WARNING: This product contains and/or generates chemicals known to the State of California to cause cancer or birth defects or other reproductive harm.

IMPORTANT: Read this owner's manual carefully and completely before trying to assemble, operate or service this fireplace. Improper use of this fireplace can cause serious injury or death from burns, fire, explosion, electrical shock and carbon monoxide poisoning.

⚠ DANGER: Carbon monoxide poisoning may lead to death!

Carbon Monoxide Poisoning: Early signs of carbon monoxide poisoning resemble the flu, with headaches, dizziness or nausea. If you have these signs, the fireplace may not be working properly. **Get fresh air at once!** Have fireplace serviced. Some people are more affected by carbon monoxide than others. These include pregnant women, people with heart or lung disease or anemia, those under the influence of alcohol and those at high altitudes.

Natural and Propane/LP Gas: Natural and propane/LP gases are odorless. An odor-making agent is added to these gases. The odor helps you detect a gas leak. However, the odor added to the gas can fade. Gas may be present even though no odor exists.

Make certain you read and understand all warnings. Keep this manual for reference. It is your guide to safe and proper operation of this fireplace.

⚠ WARNING: Any change to this heater or its controls can be dangerous.

⚠ WARNING: Do not use a blower insert, heat exchanger insert or other accessory not approved for use with this heater.

⚠ WARNING: Do not allow fans to blow directly into the fireplace. Avoid any drafts that alter burner flame patterns. Ceiling fans can create drafts that alter burner flame patterns. Altered burner patterns can cause sooting.

Due to high temperatures, the appliance should be located out of traffic and away from furniture and draperies.

Do not place clothing or other flammable material on or near the appliance. Never place any objects on the heater.

Heater base assembly becomes very hot when running heater. Keep children and adults away from hot surface to avoid burns or clothing ignition. Heater will remain hot for a time after shutdown. Allow surface to cool before touching.

Carefully supervise young children when they are in the room with heater.

You must operate this heater with a fireplace screen in place. Make sure fireplace screen is closed before running heater.

Keep the appliance area clear and free from combustible materials, gasoline and other flammable vapors and liquids.

SAFETY

Continued

1. This appliance is only for use with the type of gas indicated on the rating plate. This appliance is not convertible for use with other gases.
2. Do not place propane/LP supply tank(s) inside any structure. Locate propane/LP supply tank(s) outdoors (propane/LP units only).
3. To prevent performance problems, the use of a propane/LP tank of less than 100 lbs. capacity is not recommended (propane/LP units only).
4. If you smell gas
 - shut off gas supply
 - do not try to light any appliance
 - do not touch any electrical switch; do not use any phone in your building
 - immediately call your gas supplier from a neighbor's phone. Follow the gas supplier's instructions
 - if you cannot reach your gas supplier, call the fire department
5. This heater shall not be installed in a bedroom or bathroom.
6. Do not burn solid-fuel in a masonry or UL127 factory-built fireplace in which a vent-free room heater is installed.
7. Before installing in a solid fuel burning fireplace, the chimney flue and firebox must be cleaned of soot, creosote, ashes and loose paint by a qualified chimney cleaner. Creosote will ignite if highly heated. A dirty chimney flue may create and distribute soot within the house. Inspect chimney flue and firebox for damage. If damaged, repair flue before operating heater.
8. If fireplace has glass doors, never operate this heater with glass doors closed. If you operate heater with doors closed, heat buildup inside fireplace will cause glass to burst. Make sure there are no obstructions across openings of fireplace.
9. This log heater is designed to be smokeless. If logs ever appear to smoke, turn off heater and call a qualified service person.
Note: During initial operation, slight smoking could occur due to log curing and heater burning manufacturing residues.
10. To prevent the creation of soot, follow the instructions in *Cleaning and Maintenance*, page 19.
11. Before using furniture polish, wax, carpet cleaner or similar products, turn heater off. If heated, the vapors from these products may create a white powder residue within burner box or on adjacent walls or furniture.
12. This heater needs fresh, outside air ventilation to run properly. This heater has an Oxygen Depletion Sensing (ODS) safety shutoff system. The ODS shuts down the heater if not enough fresh air is available. See *Air for Combustion and Ventilation*, page 6. If heater keeps shutting off, see *Troubleshooting*, page 20.
13. Do not run heater
 - where flammable liquids or vapors are used or stored
 - under dusty conditions
14. Do not use this heater to cook food or burn paper or other objects.
15. Do not use heater if any part has been exposed to or under water. Immediately call a qualified service technician to inspect the room heater and to replace any part of the control system and any gas control which has been under water.
16. Do not operate heater if any log is broken. Do not operate heater if a log is chipped (dime-sized or larger).
17. Turn heater off and let cool before servicing. Only a qualified service person should service and repair heater.
18. Operating heater above elevations of 4,500 feet could cause pilot outage.
19. Provide adequate clearances around air openings.
20. Solid fuels shall not be burned in a fireplace where a decorative appliance is installed.
21. Installation and the provisions for combustion and ventilation air must conform with the *National Fuel Gas Code, ANSI Z223.1/NFPA 54*.
22. When installing as a vented appliance in a manufactured home or mobile home, the installation must conform with the *Manufactured Home Construction and Safety Standard, Title 24 CFR, Part 3280*.

PRODUCT IDENTIFICATION

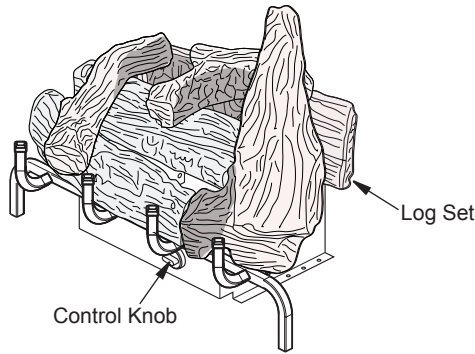

Figure 1 - Yellow Flame Vent-Free Gas Log Heater

LOCAL CODES

Install and use heater with care. Follow all local codes. In the absence of local codes, use the latest edition of *The National Fuel Gas Code ANSI Z223/NFPA 54**.

*Available from:

American National Standards Institute, Inc.
1430 Broadway
New York, NY 10018

National Fire Protection Association, Inc.
Batterymarch Park
Quincy, MA 02269

State of Massachusetts: The installation must be made by a licensed plumber or gas fitter in the Commonwealth of Massachusetts.

Sellers of unvented propane or natural gas-fired supplemental room heaters shall provide to each purchaser a copy of 527 CMR 30 upon sale of the unit.

Vent-free gas products are prohibited for bedroom and bathroom installation in the Commonwealth of Massachusetts.

UNPACKING

CAUTION: Do not remove the data plates from the grate assembly. The data plates contain important warranty and safety information.

1. Remove logs and heater base assembly from carton.

Note: Do not pick up heater base assembly by burners. This could damage heater. Always handle base assembly by grate.

2. Remove all protective packaging applied to logs and heater for shipment.
3. Check heater for any shipping damage. If heater is damaged call FMI PRODUCTS, LLC at 1-866-328-4537 for replacement parts before returning to dealer.

PRODUCT FEATURES

OPERATION

This heater is clean burning. It requires no outside venting. There is no heat loss out a vent or up a chimney. Heat is generated by realistic, dancing yellow flames. This heater is designed for vent-free operation with flue damper closed. It has been tested and approved to ANSI Z21.11.2 standard for unvented heaters. State and local codes in some areas prohibit the use of vent-free heaters.

SAFETY PILOT

This heater has a pilot with an Oxygen Depletion Sensing (ODS) safety shutoff system. The ODS/pilot is a required feature for vent-free room heaters. The ODS/pilot shuts off the heater if there is not enough fresh air.

AIR FOR COMBUSTION AND VENTILATION

⚠ WARNING: This heater shall not be installed in a room or space unless the required volume of indoor combustion air is provided by the method described in the *National Fuel Gas Code, ANSI Z223.1/NFPA 54*, the *International Fuel Gas Code*, or applicable local codes. Read the following instructions to insure proper fresh air for this and other fuel-burning appliances in your home.

Today's homes are built more energy efficient than ever. New materials, increased insulation and new construction methods help reduce heat loss in homes. Home owners weather strip and caulk around windows and doors to keep the cold air out and the warm air in. During heating months, home owners want their homes as airtight as possible.

While it is good to make your home energy efficient, your home needs to breathe. Fresh air must enter your home. All fuel-burning appliances need fresh air for proper combustion and ventilation.

Exhaust fans, fireplaces, clothes dryers and fuel burning appliances draw air from the house to operate. You must provide adequate fresh air for these appliances. This will insure proper venting of vented fuel-burning appliances.

PROVIDING ADEQUATE VENTILATION

The following are excerpts from *National Fuel Gas Code, ANSI Z223.1/NFPA 54, Air for Combustion and Ventilation*.

All spaces in homes fall into one of the three following ventilation classifications:

1. Unusually Tight Construction
2. Unconfined Space
3. Confined Space

The information on pages 6 through 8 will help you classify your space and provide adequate ventilation.

Unusually Tight Construction

The air that leaks around doors and windows may provide enough fresh air for combustion and ventilation. However, in buildings of unusually tight construction, you must provide additional fresh air.

Unusually tight construction is defined as construction where:

- a. walls and ceilings exposed to the outside atmosphere have a continuous water vapor retarder with a rating of one perm (6×10^{-11} kg per pa-sec- m^2) or less with openings gasketed or sealed and
- b. weather stripping has been added on openable windows and doors and
- c. caulking or sealants are applied to areas such as joints around window and door frames, between sole plates and floors, between wall-ceiling joints, between wall panels, at penetrations for plumbing, electrical and gas lines and at other openings.

If your home meets all of the three criteria above, you must provide additional fresh air. See [Ventilation Air From Outdoors](#), page 8.

If your home does not meet all of the three criteria above, proceed to [Determining Fresh-Air Flow For Heater Location](#).

Confined Space and Unconfined Space

The *National Fuel Gas Code ANSI Z223.1/NFPA 54* defines a confined space as a space whose volume is less than 50 cubic feet per 1,000 Btu per hour (4.8 m^3 per kw) of the aggregate input rating of all appliances installed in that space and an unconfined space as a space whose volume is not less than 50 cubic feet per 1,000 Btu per hour (4.8 m^3 per kw) of the aggregate input rating of all appliances installed in that space. Rooms communicating directly with the space in which the appliances are installed*, through openings not furnished with doors, are considered a part of the unconfined space.

* Adjoining rooms are communicating only if there are doorless passageways or ventilation grills between them.

DETERMINING FRESH-AIR FLOW FOR FIREPLACE LOCATION

Determining if You Have a Confined or Unconfined Space

Use this work sheet to determine if you have a confined or unconfined space.

Space: Includes the room in which you will install fireplace plus any adjoining rooms with doorless passageways or ventilation grills between the rooms.

AIR FOR COMBUSTION AND VENTILATION

Continued

1. Determine the volume of the space (length x width x height).

Length x Width x Height = _____ cu. ft.
(volume of space)

Example: Space size 20 ft. (length) x 16 ft. (width) x 8 ft. (ceiling height) = 2,560 cu. ft. (volume of space)

If additional ventilation to adjoining room is supplied with grills or openings, add the volume of these rooms to the total volume of the space.

2. Multiply the space volume by 20 to determine the maximum Btu/Hr the space can support.

_____ (volume of space) x 20 = (Maximum Btu/Hr the space can support)

Example: 2,560 cu. ft. (volume of space) x 20 = 51,200 (maximum Btu/Hr the space can support)

3. Add the Btu/Hr of all fuel burning appliances in the space.

Vent-free fireplace	_____ Btu/Hr
Gas water heater*	_____ Btu/Hr
Gas furnace	_____ Btu/Hr
Vented gas heater	_____ Btu/Hr
Gas fireplace logs	_____ Btu/Hr
Other gas appliances* +	_____ Btu/Hr
Total	= _____ Btu/Hr

* Do not include direct-vent gas appliances. Direct-vent draws combustion air from the outdoors and vents to the outdoors.

Example:

Gas water heater	40,000	Btu/Hr	
Vent-free fireplace	+	31,500	Btu/Hr
Total	=	71,500	Btu/Hr

4. Compare the maximum Btu/Hr the space can support with the actual amount of Btu/Hr used.

_____ Btu/Hr (maximum the space can support)

_____ Btu/Hr (actual amount of Btu/Hr used)

Example: 51,200 Btu/Hr (maximum the space can support)

71,500 Btu/Hr (actual amount of Btu/Hr used)

The space in the example is a confined space because the actual Btu/Hr used is more than the maximum Btu/Hr the space can support. You must provide additional fresh air. Your options are as follows:

- A. Rework worksheet, adding the space of an adjoining room. If the extra space provides an unconfined space, remove door to adjoining

room or add ventilation grills between rooms. See Ventilation Air From Inside Building.

- B. Vent room directly to the outdoors. See Ventilation Air From Outdoors, page 8.

- C. Install a lower Btu/Hr fireplace, if lower Btu/Hr size makes room unconfined.

If the actual Btu/Hr used is less than the maximum Btu/Hr the space can support, the space is an unconfined space. You will need no additional fresh air ventilation.

⚠ WARNING: If the area in which the heater may be operated does not meet the required volume for indoor combustion air, combustion and ventilation air shall be provided by one of the methods described in the *National Fuel Gas Code, ANSI Z223.1/NFPA 54*, the *International Fuel Gas Code*, or applicable local codes.

VENTILATION AIR

Ventilation Air From Inside Building

This fresh air would come from an adjoining unconfined space. When ventilating to an adjoining unconfined space, you must provide two permanent openings: one within 12" of the ceiling and one within 12" of the floor on the wall connecting the two spaces (see options 1 and 2, Figure 2). You can also remove door into adjoining room (see option 3, Figure 2). Follow the *National Fuel Gas Code ANSI Z223.1/NFPA 54 Air for Combustion and Ventilation* for required size of ventilation grills or ducts.

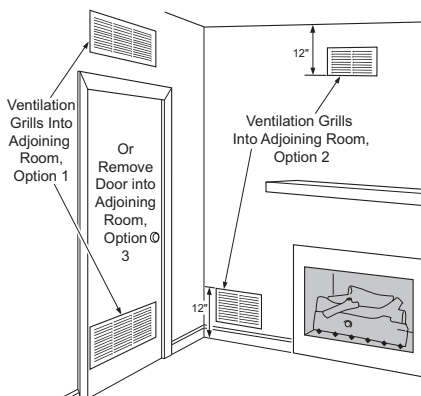

Figure 2 - Ventilation Air from Inside Building

AIR FOR COMBUSTION AND VENTILATION

Continued

Ventilation Air From Outdoors

Provide extra fresh air by using ventilation grills or ducts. You must provide two permanent openings: one within 12" of the ceiling and one within 12" of the floor. Connect these items directly to the outdoors or spaces open to the outdoors. These spaces include attics and crawl spaces. Follow the *National Fuel Gas Code ANSI Z223.1/NFPA 54, Air for Combustion and Ventilation* for required size of ventilation grills or ducts.

IMPORTANT: Do not provide openings for inlet or outlet air into attic if attic has a thermostat-controlled power vent. Heated air entering the attic will activate the power vent.

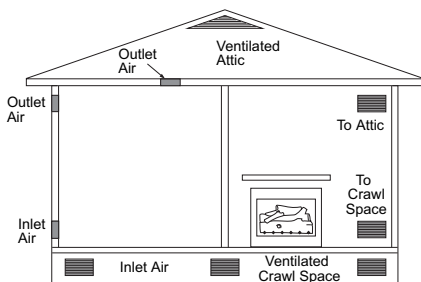

Figure 3 - Ventilation Air from Outdoors

INSTALLATION

NOTICE: This heater is intended for use as supplemental heat. Use this heater along with your primary heating system. Do not install this heater as your primary heat source. If you have a central heating system, you may run system's circulating blower while using heater. This will help circulate the heat throughout the house. In the event of a power outage, you can use this heater as your primary heat source.

WARNING: A qualified service person must install heater. Follow all local codes.

NOTICE: State or local codes may only allow operation of this appliance in a vented configuration. Check your state or local codes.

WARNING: Before installing in a solid fuel burning fireplace, the chimney flue and firebox must be cleaned of soot, creosote, ashes and loose paint by a qualified chimney cleaner. Creosote will ignite if highly heated. A dirty chimney flue may create and distribute soot within the house. Inspect chimney flue and firebox for damage. If damaged, repair flue before operating heater.

WARNING: Seal any fresh air vents or ash clean-out doors located on floor or wall of fireplace. If not, drafting may cause pilot outage or sooting. Use a heat-resistant sealant. Do not seal chimney flue damper.

WARNING: Never install the heater

- in a bedroom or bathroom
- in a recreational vehicle
- where curtains, furniture, clothing or other flammable objects are less than 36" from front or 42" from top of heater. For side clearances see Figure 4, page 9
- in high traffic areas
- in windy or drafty areas

INSTALLATION

Continued

⚠ CAUTION: This heater creates warm air currents. These currents move heat to wall surfaces next to heater. Installing heater next to vinyl or cloth wall coverings or operating heater where impurities (such as, but not limited to, tobacco smoke, aromatic candles, cleaning fluids, oil or kerosene lamps, etc.) in the air exist, may discolor walls or cause odors.

IMPORTANT: Vent-free heaters add moisture to the air. Although this is beneficial, installing heater in rooms without enough ventilation air may cause mildew to form from too much moisture. See *Air for Combustion and Ventilation*, page 6.

CHECK GAS TYPE

Use only the correct gas type (natural or propane/LP) for your unit. If your gas supply is not correct, do not install heater. Call dealer where you bought heater for proper type heater.

⚠ WARNING: This appliance is equipped for either natural gas or propane/LP gas but not both. Gas type is indicated on the rating plate. Field conversion is not permitted.

INSTALLATION AND CLEARANCES (Vent-Free Operation Only)

⚠ WARNING: Maintain the minimum clearances. If you can, provide greater clearances from floor, ceiling and adjoining wall.

**MINIMUM FIREPLACE CLEARANCE
TO COMBUSTIBLE MATERIALS**
Side Wall 16", Ceiling 42", Front 36"

LOG SIZING REQUIREMENTS Minimum Firebox Size

Height 17", Depth 13.5", Front Width 28",
Rear Width* 20.5"

*Measured at 13.5" Depth

Carefully follow the instructions below. This will ensure safe installation into a masonry, UL 127-listed manufactured fireplace or certified vent-free firebox.

MINIMUM CLEARANCES FOR SIDE COMBUSTIBLE MATERIAL, SIDE WALL AND CEILING

A. Clearances from the side of the fireplace cabinet to any combustible material and wall should follow diagram in Figure 4.

Example: The face of a mantel, bookshelf, etc. is made of combustible material and protrudes 3 1/2" from the wall. This combustible material must be 4" from the side of the fireplace cabinet (see Figure 4).

Note: When installing your gas logs into a manufactured firebox, follow firebox manufacturer's instructions for minimum clearances to combustible materials.

B. Clearances from the top of the fireplace opening to the ceiling should not be less than 42".

NOTICE: Manual control heaters may be used as a vented product. If so, you must always run heater with chimney flue damper open. If running heater with damper open, noncombustible material above fireplace opening is not needed. Go to *Installing Damper Clamp Accessory for Vented Operation*, page 11.

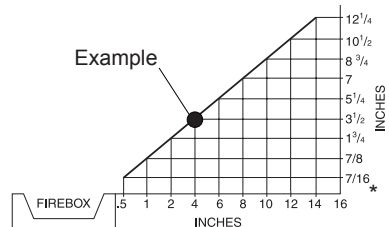

*Minimum 16" from Side Wall

**Figure 4 - Minimum Clearance for
Combustible to Wall**

INSTALLATION

Continued

MINIMUM NONCOMBUSTIBLE MATERIAL CLEARANCES

If Not Using Mantel

Note: If using a mantel, proceed to *If Using Mantel*. If not using a mantel, follow the information below.

You must have noncombustible material(s) above the fireplace opening. Noncombustible materials (such as slate, marble, tile, etc.) must be at least 1/2" thick. With sheet metal, you must have noncombustible material behind it. Noncombustible material must extend at least 12" up (for all models). See Figure 5 for minimum clearances.

Noncombustible Material Distance (A)	Requirements for Safe Installation
12" or more	Noncombustible material OK.
Between 8" and 12"	24" Models: Install fireplace hood accessory (GA6050 or GA6053, see <i>Accessories</i> , page 26). 18" Model: Noncombustible material OK.
Less than 8"	Noncombustible material must be extended to at least 8". See <i>Between 8" and 12"</i> , above. If you cannot extend material, you must operate heater with flue damper open and damper clamp installed.

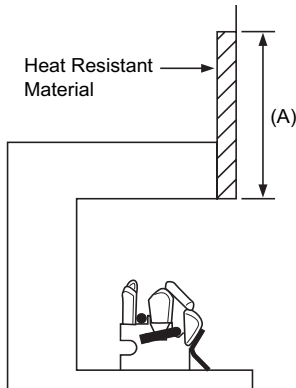

Figure 5 - Heat Resistant Material (Slate, Marble, Tile, etc.) Above Fireplace

If Using Mantel

You must have noncombustible material(s) above the fireplace opening. Noncombustible materials (such as slate, marble, tile, etc.) must be at least 1/2" thick. With sheet metal, you must have noncombustible material behind it. Noncombustible material must extend at least 12" up. See Figures 5 and 6 and Figure 7 on page 11 for minimum clearances.

MANTEL CLEARANCES

In addition to meeting noncombustible material clearances, you must also meet required clearances between fireplace opening and mantel shelf. If you do not meet the clearances listed below, you will need a hood.

Determining Minimum Mantel Clearance

If you meet minimum clearance between mantel shelf and top of fireplace opening, a hood is not required (see Figure 6).

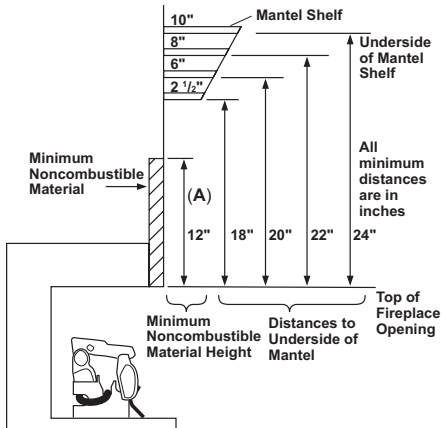

Figure 6 - Minimum Mantel Clearances Without Using Hood

INSTALLATION

Continued

NOTICE: Surface temperatures of adjacent walls and mantels become hot during operation. Walls and mantels above the firebox may become hot to the touch. If installed properly, these temperatures meet the requirement of the national product standard. Follow all minimum clearances shown in this manual.

NOTICE: If your installation does not meet the minimum clearances shown, you must do one of the following:

- raise the mantel to an acceptable height

FLOOR CLEARANCES

- A. If installing appliance on the floor level, you must maintain the minimum distance of 14" to combustibles (see Figure 7).
- B. If combustible materials are less than 14" to the fireplace, you must install appliance at least 5" above the combustible flooring (see Figure 8).

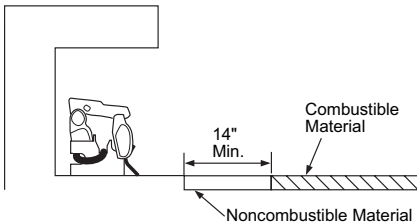

Figure 7 - Minimum Fireplace Clearances If Installed at Floor Level

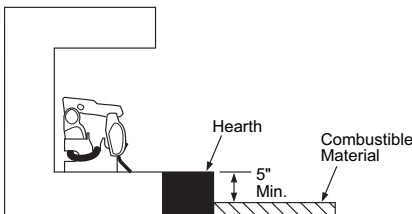

Figure 8 - Minimum Fireplace Clearances Above Combustible Flooring

INSTALLING DAMPER CLAMP ACCESSORY FOR VENTED OPERATION

Note: When used as a vented heater, appliance must be installed only in a solid-fuel burning fireplace with a working flue and constructed of noncombustible material.

For Massachusetts Residents Only: Installation of this gas log set as a vented appliance in the Commonwealth of Massachusetts requires the damper be permanently removed or welded in the fully open position.

If your heater is a manually-controlled model, you may use this heater as a vented product. There are three reasons for operating your heater in the vented mode.

1. The fireplace does not meet the clearance to combustibles requirements for vent-free operation.
2. State or local codes do not permit vent-free operation.
3. You prefer vented operation.

If reasons number 1 or 2 above apply to you, you must permanently open chimney flue damper. You must install the damper clamp accessory (to order, see *Accessories*, page 26). This will insure vented operation (see Figure 9.). The damper clamp will keep damper open. Installation instructions are included with clamp accessory.

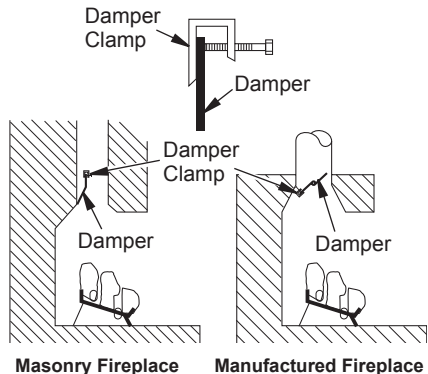

Figure 9 - Attaching Damper Clamp

INSTALLATION

Continued

See chart below for minimum permanent flue opening you must provide. Attach damper clamp so the minimum permanent flue opening will be maintained at all times.

Area of Various Standard Round Flues	
Diameter	Area
5"	20 sq. inches
6"	29 sq. inches
7"	39 sq. inches
8"	51 sq. inches

Chimney Height	Minimum Permanent Flue Opening
6' to 15'	39 sq. inches
15' to 30'	29 sq. inches

INSTALLING HEATER BASE ASSEMBLY

⚠ CAUTION: Do not remove the data plates attached to the heater base assembly. The data plates contain important warranty and safety information.

⚠ WARNING: You must secure this heater to fireplace floor. If not, heater will move when you adjust controls. Moving heater may cause a gas leak.

⚠ WARNING: If installing in a sunken fireplace, special care is needed. You must raise the fireplace floor to allow access to heater control panel. This will insure adequate air flow and guard against sooting and controls being damaged. Raise fireplace floor with noncombustible material. Make sure material is secure.

⚠ CAUTION: Do not pick up heater base assembly by the burner. This could damage heater. Only handle base assembly by grates.

IMPORTANT: Make sure heater burners are level. If heater is not level, heater will not work properly.

Installation Items Needed

- hardware package (provided with heater)
- approved flexible gas hose (if allowed by local codes)
- sealant (resistant to propane/LP gas, not provided)
- electric drill with 3/16" drill bit
- flathead screwdriver

1. Apply pipe joint sealant lightly to male threads of fitting to be threaded into gas regulator. Connect approved flexible gas hose to gas regulator of heater (see Figure 10).

IMPORTANT: Hold gas regulator with wrench when connecting flexible gas hose.

2. Locate masonry screws in hardware package.
3. Position heater base assembly in fireplace.
4. Place logs in their proper position on heater base (see [Installing Logs](#), page 16).
5. Center heater base and logs front-to-front and side-to-side in fireplace.
6. Carefully remove logs without moving heater base.
7. Mark screw locations through holes in

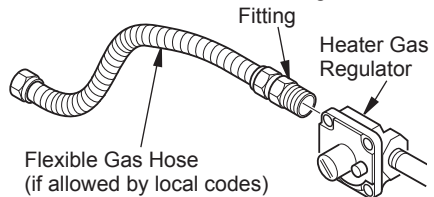

Figure 10 - Attaching Flexible Gas Hose to Heater Gas Regulator

INSTALLATION

Continued

mounting brackets (see Figure 11). If installing in a brick-bottom fireplace, mark screw locations in mortar joint of bricks.

8. Remove heater base from fireplace.
9. Drill holes at marked locations using 3/16" drill bit.
10. Attach base assembly to fireplace floor using two masonry screws (in hardware package) (see Figure 11).

CONNECTING TO GAS SUPPLY

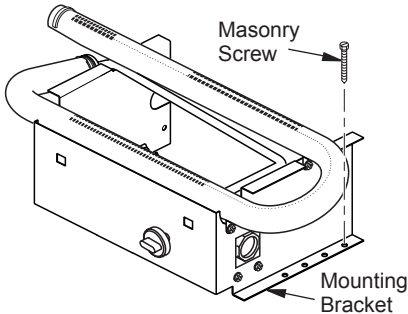

Figure 11 - Attaching Base Assembly to Fireplace Floor

WARNING: This appliance requires a 1/2" NPT (National Pipe Thread) inlet connection to the pressure regulator.

WARNING: A qualified service person must connect heater to gas supply. Follow all local codes.

CAUTION: Never connect propane/LP heater directly to the propane/LP supply. Propane/LP heaters require an external regulator (not supplied). Install the external regulator between the heater and propane/LP supply.

WARNING: For natural gas units, never connect heater to private (non-utility) gas wells. This gas is commonly known as wellhead gas.

Installation Items Needed

Before installing heater, make sure you have the items listed below.

- external regulator (supplied by installer)
- piping (check local codes)
- sealant (resistant to propane/LP gas)
- equipment shutoff valve *
- test gauge connection *
- sediment trap
- tee joint
- pipe wrench

* A equipment shutoff valve with 1/8" NPT tap is an acceptable alternative to test gauge connection. Purchase the optional equipment shutoff valve from your dealer.

For propane/LP gas, installer must supply an external regulator. External regulator will reduce incoming gas pressure. You must reduce incoming gas pressure to between 11" and 14" of water. If you do not reduce incoming gas pressure, heater regulator damage could occur. Install external regulator with vent pointing down as shown in Figure 12. Pointing vent down protects it from freezing rain or sleet.

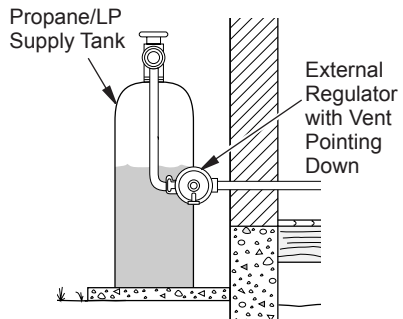

Figure 12 - External Regulator With Vent Pointing Down

INSTALLATION

Continued

⚠ CAUTION: Use only new, black iron or steel pipe. Internally-tinned copper tubing may be used in certain areas. Check your local codes. Use pipe of 1/2" diameter or greater to allow proper gas volume to heater. If pipe is too small, undue loss of volume will occur.

Installation must include an equipment shutoff valve, union and plugged 1/8" NPT tap. Locate NPT tap within reach for test gauge hook up. NPT tap must be upstream from heater (see Figure 13).

IMPORTANT: Install equipment shutoff valve in an accessible location. Main gas valve is for turning on or shutting off gas to appliance.

Check your building codes for any special requirements for locating equipment shutoff valve to fireplaces.

Apply pipe joint sealant lightly to male NPT threads. This will prevent excess sealant from going into pipe. Excess sealant in pipe could result in clogged heater valves.

⚠ WARNING: Use pipe joint sealant that is resistant to liquid petroleum (LP) gas.

We recommend that you install sediment trap in supply line as shown in Figure 13. Locate sediment trap where it is within reach for cleaning. Install in piping system between fuel supply and heater. Locate sediment trap where trapped matter is not likely to freeze. A sediment trap traps moisture and contaminants. This keeps them from going into heater controls. If sediment trap is not installed or is installed wrong, heater may not run properly.

⚠ CAUTION: Avoid damage to regulator. Hold gas regulator with wrench when connecting it to gas piping and/or fittings.

CHECKING GAS CONNECTIONS

⚠ WARNING: Test all gas piping and connections, internal and external to unit, for leaks after installing or servicing. Correct all leaks at once.

⚠ WARNING: Never use an open flame to check for a leak. Apply a commercial leak detection solution to all joints. Bubbles forming show a leak. Correct all leaks at once.

⚠ CAUTION: For propane/LP units, make sure external regulator has been installed between propane/LP supply and heater. See guidelines under Connecting to Gas Supply, page 13.

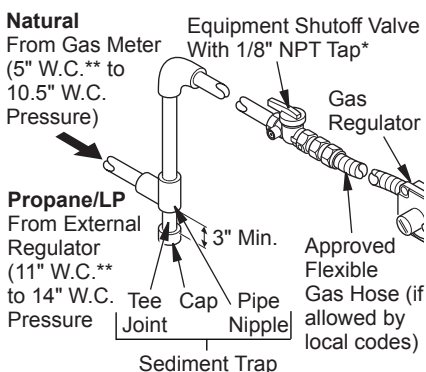

Figure 13 - Gas Connection

* Purchase optional equipment shutoff valve from your dealer.

** Min. inlet pressure for purpose of input adjustment.

INSTALLATION

Continued

PRESSURE TESTING GAS SUPPLY PIPING SYSTEM

Test Pressures In Excess Of 1/2 PSIG (3.5 kPa)

1. Disconnect appliance with its appliance main gas valve (control valve) and equipment shutoff valve from gas supply piping. Pressures in excess of 1/2 psig will damage heater regulator.
2. Cap off open end of gas pipe where equipment shutoff valve was connected.
3. Pressurize supply piping system by either opening propane/LP supply tank valve for propane/LP gas or opening main gas valve located on or near gas meter for natural gas or using compressed air.
4. Check all joints of gas supply piping system. Apply a commercial leak detection solution to all joints. Bubbles forming show a leak.
5. Correct all leaks at once.
6. Reconnect heater and equipment shutoff valve to gas supply. Check reconnected fittings for leaks.

Test Pressures Equal To or Less Than 1/2 PSIG (3.5 kPa)

1. Close equipment shutoff valve (see Figure 14).
2. Pressurize supply piping system by either opening propane/LP supply tank valve for propane/LP gas or opening main gas valve located on or near gas meter for natural gas or using compressed air.
3. Check all joints from gas meter (natural gas) or propane/LP supply to equipment shutoff valve (see Figure 15 or 16). Apply a commercial leak detection solution to all joints. Bubbles forming show a leak.
4. Correct all leaks at once.

PRESSURE TESTING HEATER GAS CONNECTIONS

1. Open equipment shutoff valve (see Figure 14).
2. Open main gas valve located on or near gas meter for natural gas or open propane/LP supply tank valve.
3. Make sure control knob of heater is in the OFF position.

4. Check all joints from gas meter (natural gas) or propane/LP supply to equipment shutoff valve (see Figure 15 or 16). Apply a commercial leak detection solution to all joints. Bubbles forming show a leak.
5. Correct all leaks at once.
6. Light heater (see [Operation](#), page 17). Check all other internal joints for leaks.
7. Turn off heater (see [To Turn Off Gas to Appliance](#), page 18).

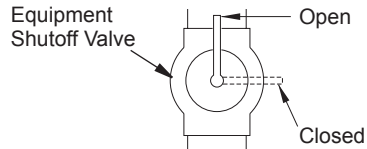

Figure 14 - Equipment Shutoff Valve

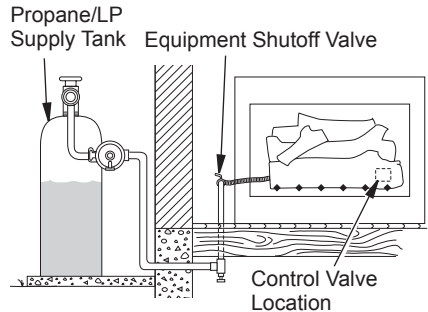

Figure 15 - Checking Gas Joints (Propane/LP Gas Only)

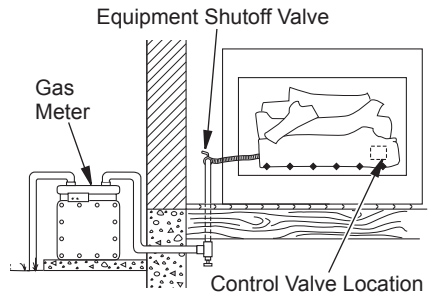

Figure 16 - Checking Gas Joints (Natural Gas Only)

INSTALLATION

Continued

INSTALLING LOGS

⚠ WARNING: Failure to position the parts in accordance with these diagrams or failure to use only parts specifically approved with this heater may result in property damage or personal injury.

⚠ CAUTION: After installation and periodically thereafter, check to ensure that no flame comes in contact with any log. With the heater set to High, check to see if flames contact any log. If so, reposition logs according to the log installation instructions in this manual. Flames contacting logs will create soot.

It is very important to install these logs exactly as instructed. Do not modify logs. Only use logs supplied with heater.

1. Place rear log onto base. Holes in bottom of log must seat over pins on base as shown in Figure 17.
2. Place center log onto base. Holes in bottom of log must seat over pins on base as shown in Figure 17.
3. Place front log onto grate as shown in Figure 18. Front log has cut outs for the fingers of the grate to fit into.

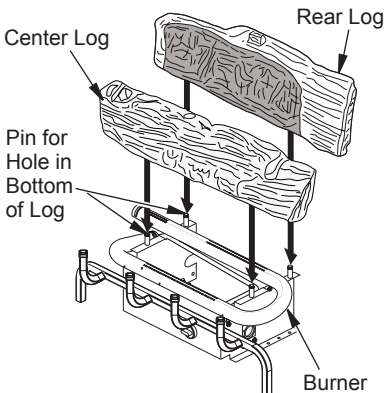

Figure 17 - Installing Rear and Middle Logs

4. Place left crossover log as shown in Figure 19. Match square peg on top of center log with square hole on bottom of left crossover log. Match pin on top of front log with round hole on bottom of left crossover log.
5. Place center crossover log as shown in Figure 19. Match square peg on top of rear log with square hole on bottom of center crossover log. Match pin on top of center log with round hole on bottom of center crossover log.
6. Place left front crossover log as shown in Figure 19. Log should rest on the grate and fit into recess area on the center log.

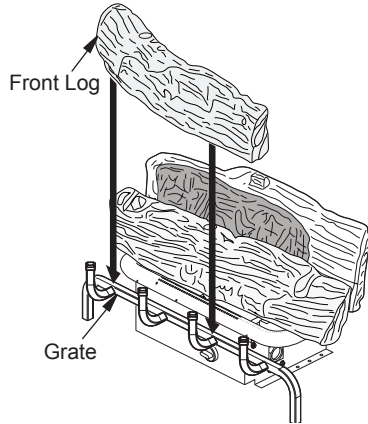

Figure 18 - Installing Front Log

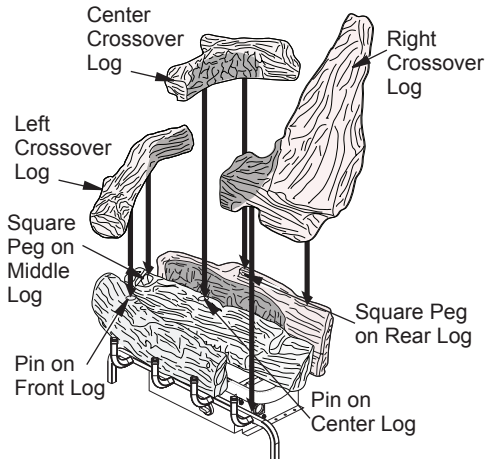

Figure 19 - Installing Left, Center and Right Crossover Logs

OPERATION

FOR YOUR SAFETY READ BEFORE LIGHTING

⚠ WARNING: If you do not follow these instructions exactly, a fire or explosion may result causing property damage, personal injury or loss of life.

- A. This appliance has a pilot which must be lighted by hand. When lighting the pilot, follow these instructions exactly.
- B. **BEFORE LIGHTING** smell all around the appliance area for gas. Be sure to smell next to the floor because some gas is heavier than air and will settle on the floor.
- WHAT TO DO IF YOU SMELL GAS**
- Do not try to light any appliance.
 - Do not touch any electric switch; do not use any phone in your building.
 - Immediately call your gas supplier from a neighbor's phone. Follow the gas supplier's instructions.
 - If you cannot reach your gas supplier, call the fire department.
- C. Use only your hand to push in or turn the gas control knob. Never use tools. If the knob will not push in or turn by hand, don't try to repair it, call a qualified service technician or gas supplier. Force or attempted repair may result in a fire or explosion.
- D. Do not use this appliance if any part has been under water. Immediately call a qualified service technician to inspect the appliance and to replace any part of the control system and any gas control which has been under water.

LIGHTING INSTRUCTIONS

- ⚠ WARNING**
- If fireplace has glass doors, never operate this heater with glass doors closed. If you operate heater with doors closed, heat buildup inside fireplace will cause glass to burst. Make sure there are no obstructions across openings of fireplace.
 - You must operate this heater with a fireplace screen in place. Make sure fireplace screen is closed before running heater.

NOTICE: During initial operation of new heater, burning logs will give off a paper-burning smell. Orange flame will also be present. Open damper or window to vent smell. This will only last a few hours.

Note: Home owners generally prefer to operate their heater with chimney damper closed. This will put all of the heat into room. However, there may be times you will desire full flames of HI heat setting but will find heat output excessive. You can open chimney damper (if you have one) fully or partially to release some heat.

⚠ WARNING: Damper handle will be hot if heater has been running.

1. STOP! Read the safety information, column 1.
2. Make sure equipment shutoff valve is fully open.
3. Press in and turn control knob clockwise  to the OFF position.
4. Wait five (5) minutes to clear out any gas. Then smell for gas, including near the floor. If you smell gas, STOP! Follow "B" in the safety information, column 1. If you don't smell gas, go to the next step.

OPERATION

Continued

- Press in control knob and turn counterclockwise ↶ to the PILOT position (see Figure 20). The ignitor will spark once. Keep control knob pressed in for 5 seconds. If control knob does not pop up when released, contact a qualified service person or gas supplier for repairs.

Note: You may be running this heater for the first time after hooking up to gas supply. If so, the control knob may need to be pressed in for 30 seconds or more. This will allow air to bleed from the gas system.

- Turn control knob clockwise ↷ to OFF position. Press in control knob and turn counterclockwise ↶ to PILOT position. This will light pilot. Pilot is attached to rear of burner. If needed, repeat this process until pilot lights.

Note: If pilot does not stay lit, contact a qualified service person or gas supplier for repairs. Until repairs are made, light pilot with match. To light pilot with match, see [Manual Lighting Procedure](#).

- Keep control knob pressed in for 30 seconds after lighting pilot. After 30 seconds, release control knob.

Note: If pilot goes out, repeat steps 3 through 7.

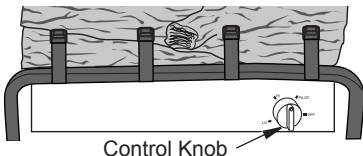

Figure 20 - Control Knob and Ignitor Button Location

- If control knob does not pop out when released, contact a qualified service person or gas supplier for repairs.

- Slightly press and turn control knob counterclockwise ↶ to desired heating level. The burner should light. Set control knob to HI or LO.

⚠ WARNING: Do not operate heater between PILOT and HIGH positions.

- To leave pilot lit and shut off burners only, turn control knob clockwise ↷ to the PILOT position.

⚠ CAUTION: Do not try to adjust heating levels by using the equipment shutoff valve.

TO TURN OFF GAS TO APPLIANCE

- Turn control knob clockwise ↷ to OFF position.
- Close equipment shutoff valve (see Figure 14, page 15).

MANUAL LIGHTING PROCEDURE

- Follow steps 1 through 5 under [Lighting Instructions](#) beginning on page 17.
- Press control knob and light pilot with match.
- Keep control knob pressed in for 30 seconds after lighting pilot. After 30 seconds, release control knob. Now follow step 8 under [Lighting Instructions](#), above.

INSPECTING BURNERS

Check pilot flame pattern and burner flame patterns often.

PILOT FLAME PATTERN

Figure 21 shows a correct pilot flame pattern. Figure 22 shows an incorrect pilot flame pattern. Incorrect pilot flame is not touching thermocouple. This will cause the thermocouple to cool. When thermocouple cools, heater will shut down.

If pilot flame pattern is incorrect, as shown in Figure 22

- turn heater off (see [To Turn Off Gas to Appliance](#), above)
- see [Troubleshooting](#), page 20

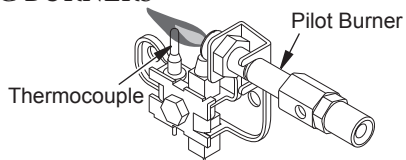

Figure 21 - Correct Pilot Flame Pattern

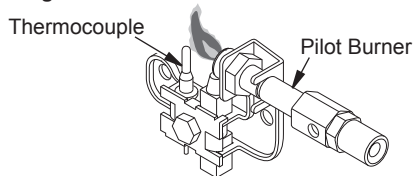

Figure 22 - Incorrect Pilot Flame Pattern

INSPECTING BURNERS

Continued

Note: Pilot flame on natural gas units will have a slight curve, but flame should be blue and have no yellow or orange color.

BURNER PRIMARY AIR HOLES

Air is drawn into burner through holes in fitting at entrance to burner. These holes may become blocked with dust or lint. Periodically inspect these holes for any blockage and clean as necessary. Blocked air holes will create soot.

MAIN BURNER

Periodically inspect all burner flame holes with heater running. All slotted burner flame holes should be open with yellow flame present. All round burner flame holes should be open with a small blue flame present. Some burner flame holes may become blocked by debris or rust, with no flame present. If so, turn off heater and let cool. Remove blockage, blocked burner flame holes will create soot.

CLEANING AND MAINTENANCE

WARNING: Turn off heater and let cool before cleaning.

CAUTION: You must keep control areas, burner and circulating air passageways of heater clean. Inspect these areas of heater before each use. Have heater inspected yearly by a qualified service person. Heater may need more frequent cleaning due to excessive lint from carpeting, bedding material, pet hair, etc.

WARNING: Failure to keep the primary air opening(s) of the burner(s) clean may result in sooting and property damage.

Once every year a qualified agency or certified chimney sweep should examine and clean the venting system of fireplace.

ODS/PILOT AND BURNER

Use a vacuum cleaner or small, soft bristled brush to clean.

BURNER ORIFICE HOLDER AND PILOT AIR INLET HOLE

The primary air inlet holes allow the proper amount of air to mix with the gas. This provides a clean burning flame. Keep these holes clear of dust, dirt and lint. Clean these air inlet holes prior to each heating season. Blocked air holes will create soot. We recommend that you clean the unit every three months during operation and have heater inspected yearly by a qualified service person.

We also recommend that you keep burner tube and pilot assembly clean and free of dust and dirt. To clean these parts we recommend using compressed air no greater than 30 PSI. Your local computer store, hardware store or home center may carry compressed air in a can. If using compressed air in a can, please follow directions on can. If you don't follow directions on can, you could damage pilot assembly.

1. Shut off unit, including pilot. Allow unit to cool for at least thirty minutes.
2. Inspect burner, pilot and primary air inlet holes on orifice holder for dust and dirt (see Figure 23).
3. Blow air through ports/slots and holes in burner.
4. Check orifice holder located at end of burner tube again. Remove any large particles of dust, dirt, lint or pet hair with a soft cloth or vacuum cleaner nozzle.

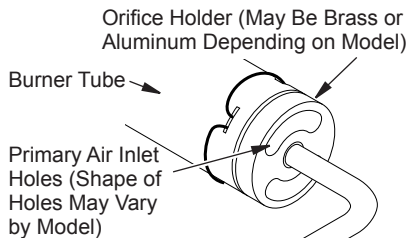

Figure 23 - Orifice Holder On Outlet Burner Tube

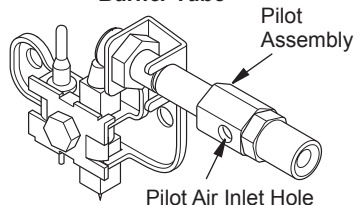

Figure 24 - Pilot Inlet Air Hole

CLEANING AND MAINTENANCE

Continued

5. Blow air into primary air holes on orifice holder.
6. In case any large clumps of dust have now been pushed into burner, repeat steps 3 and 4.

Clean pilot assembly also. A yellow tip on pilot flame indicates dust and dirt in pilot assembly. There is a small pilot air inlet hole about 2" from where pilot flame comes out of pilot assembly (see Figure 24, page 19). With unit off, lightly blow air through air inlet hole. You may blow through a drinking straw if compressed air is not available.

LOGS

- If you remove logs for cleaning, refer to *Installing Logs*, page 16, to properly replace logs.
- Replace log(s) if broken or chipped (dime-sized or larger).

BURNER PRIMARY AIR HOLES

Air is drawn into burner through the 8 holes in brass fitting at entrance to burner. These holes may become blocked with dust or lint. Periodically inspect these holes for any blockage and clean as necessary. Blocked air holes will create soot.

TROUBLESHOOTING



WARNING: Turn off and unplug heater and let cool before servicing. Only a qualified service person should service and repair heater.



CAUTION: Never use a wire, needle or similar object to clean ODS/pilot. This can damage ODS/pilot unit.

Note: All troubleshooting items are listed in order of operation.

OBSERVED PROBLEM	POSSIBLE CAUSE	REMEDY
When control knob is pressed in and turned to PILOT, there is not spark at ODS/pilot	1. Ignitor electrode not connected to ignitor cable	1. Reconnect ignitor cable
	2. Ignitor cable pinched or wet	2. Free ignitor cable if pinched by any metal or tubing. Keep ignitor cable dry
	3. Broken ignitor cable	3. Replace valve
	4. Bad piezo ignitor	4. Replace valve
	5. Ignitor electrode broken	5. Replace valve
	6. Ignitor electrode positioned wrong	6. Replace valve
When control knob is pressed in and turned to PILOT, there is spark at ODS/pilot but no ignition	1. Gas supply turned off or equipment shutoff valve closed	1. Turn on gas supply or open equipment shutoff valve
	2. Control knob not in PILOT position	2. Turn control knob to PILOT position
	3. Control knob not pressed in while in PILOT position	3. Press in control knob while in PILOT position
	4. Air in gas lines when installed	4. Continue holding down control knob. Repeat igniting operation until air is removed
	5. Depleted gas supply (propane/LP only)	5. Contact local propane/LP gas company
	6. ODS/pilot is clogged	6. Clean ODS/pilot (see <i>Cleaning and Maintenance</i> , page 19) or replace ODS/pilot assembly
	7. Gas regulator setting is not correct	7. Replace gas regulator

TROUBLESHOOTING

Continued

OBSERVED PROBLEM	POSSIBLE CAUSE	REMEDY
<p>ODS/pilot lights but flame goes out when control knob is released</p>	<ol style="list-style-type: none"> 1. Control knob not fully pressed in 2. Control knob not pressed in long enough 3. Equipment shutoff valve not fully open 4. Pilot flame not touching thermocouple, which allows thermocouple to cool, causing pilot flame to go out. This problem could be caused by one or both of the following: <ol style="list-style-type: none"> A) Low gas pressure B) Dirty or partially clogged ODS/pilot 5. Thermocouple connection loose at control valve 6. Thermocouple damaged 7. Control valve damaged 	<ol style="list-style-type: none"> 1. Press in control knob fully 2. After ODS/pilot lights, keep control knob pressed in 30 seconds 3. Fully open equipment shut-off valve 4. A) Contact local natural or propane/LP gas company B) Clean ODS/pilot (see <i>Cleaning and Maintenance</i>, page 19) or replace ODS/pilot assembly 5. Hand tighten until snug, then tighten 1/4 turn more 6. Replace pilot assembly 7. Replace control valve
<p>Burner does not light after ODS/pilot is lit</p>	<ol style="list-style-type: none"> 1. Burner orifice clogged 2. Inlet gas pressure is too low 	<ol style="list-style-type: none"> 1. Clean burner (see <i>Cleaning and Maintenance</i>, page 19) or replace burner orifice 2. Contact local natural or propane/LP gas company
<p>Delayed ignition of burner</p>	<ol style="list-style-type: none"> 1. Manifold pressure is too low 2. Burner orifice clogged 	<ol style="list-style-type: none"> 1. Contact local natural or propane/LP gas company 2. Clean burner (see <i>Cleaning and Maintenance</i>, page 19) or replace burner orifice
<p>Burner backfiring during combustion</p>	<ol style="list-style-type: none"> 1. Burner orifice is clogged or damaged 2. Damaged burner 3. Gas regulator defective 	<ol style="list-style-type: none"> 1. Clean burner (see <i>Cleaning and Maintenance</i>, page 19) or replace burner orifice 2. Replace damaged burner 3. Replace gas regulator

TROUBLESHOOTING

Continued

OBSERVED PROBLEM	POSSIBLE CAUSE	REMEDY
Slight smoke or odor during initial operation	<ol style="list-style-type: none"> 1. Not enough air 2. Gas regulator defective 3. Residues from manufacturing processes and logs curing 	<ol style="list-style-type: none"> 1. Check burner for dirt and debris. If found, clean burner (see <i>Cleaning and Maintenance</i>, page 19) 2. Replace gas regulator 3. Problem will stop after a few hours of operation
Moisture/condensation noticed on windows	<ol style="list-style-type: none"> 1. Not enough combustion/ventilation air 	<ol style="list-style-type: none"> 1. Refer to <i>Air for Combustion and Ventilation</i> requirements (page 6)
Heater produces a whistling/noise when burner is lit	<ol style="list-style-type: none"> 1. Turning control knob to HI position when burner is cold 2. Air in gas line 3. Air passageways on heater blocked 4. Dirty or partially clogged burner orifice 	<ol style="list-style-type: none"> 1. Turn control knob to LO position and let warm up for a minute 2. Operate burner until air is removed from line. Have gas line checked by local natural or propane/LP gas company 3. Observe minimum installation clearances (see page 9) 4. Clean burner (see <i>Cleaning and Maintenance</i>, page 19) or replace burner orifice
White powder residue forming within burner box or on adjacent walls or furniture	<ol style="list-style-type: none"> 1. When heated, vapors from furniture polish, wax, carpet cleaners, etc. may turn into a white powder residue 	<ol style="list-style-type: none"> 1. Turn heater off when using furniture polish, wax, carpet cleaners or similar products
Heater produces a clicking/ticking noise just after burner is lit or shut off	<ol style="list-style-type: none"> 1. Metal expanding while heating or contracting while cooling 	<ol style="list-style-type: none"> 1. This is normal with most heaters. If noise is excessive, contact qualified service person

TROUBLESHOOTING

Continued



WARNING: If you smell gas

- Shut off gas supply.
- Do not try to light any appliance.
- Do not touch any electrical switch; do not use any phone in your building.
- Immediately call your gas supplier from a neighbor's phone. Follow the gas supplier's instructions.
- If you cannot reach your gas supplier, call the fire department.

Operating heater where impurities in air exist may create odors. Cleaning supplies, paint, paint remover, cigarette smoke, cements and glues, new carpet or textiles, etc., create fumes. These fumes may mix with combustion air and create odors. These odors will disappear over time.

OBSERVED PROBLEM	POSSIBLE CAUSE	REMEDY
Heater produces unwanted odors	<ol style="list-style-type: none"> 1. Heater burning vapors from paint, hair spray, glues, cleaners, chemicals, new carpet, etc. (See <i>IMPORTANT</i> statement above) 2. Low fuel supply (propane/LP only) 3. Gas leak. See Warning statement above 	<ol style="list-style-type: none"> 1. Open window and ventilate room. Stop using odor causing products while heater is running 2. Refill supply tank (propane/LP only) 3. Locate and correct all leaks (see <i>Checking Gas Connections</i>, page 14)
Heater shuts off in use (ODS operates)	<ol style="list-style-type: none"> 1. Not enough fresh air is available 2. Low line pressure 3. ODS/pilot is partially clogged 	<ol style="list-style-type: none"> 1. Open window and/or door for ventilation 2. Contact local natural or propane/LP gas company 3. Clean ODS/pilot (see <i>Cleaning and Maintenance</i>, page 19)
Gas odor even when control knob is in OFF position	<ol style="list-style-type: none"> 1. Gas leak. See Warning statement above 2. Control valve defective 	<ol style="list-style-type: none"> 1. Locate and correct all leaks (see <i>Checking Gas Connections</i>, page 14) 2. Replace control valve
Gas odor during combustion	<ol style="list-style-type: none"> 1. Foreign matter between control valve and burner 2. Gas leak. See Warning statement above 	<ol style="list-style-type: none"> 1. Take apart gas tubing and remove foreign matter 2. Locate and correct all leaks (see <i>Checking Gas Connections</i>, page 14)

PARTS

MODELS HD18NB, HD18PB, HD24NB AND HD24PB

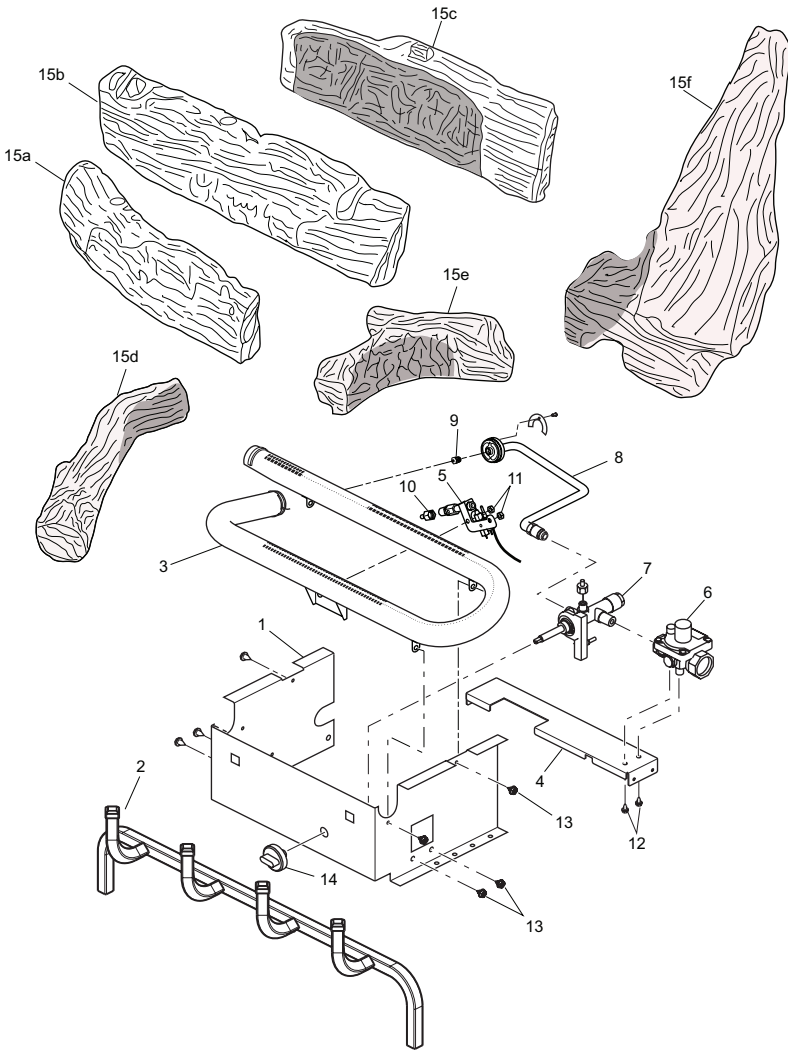

PARTS

This list contains replaceable parts used in your heater. When ordering parts, follow the instructions listed under Replacement Parts on page 26 of this manual.

KEY NO.	PART NO.	DESCRIPTION	HD18NB	HD18PB	HD24NB	HD24PB	QTY.
1	**	Log Base	•	•	•	•	1
2	126356-01	Cast Iron Grate	•	•	•	•	1
3	120786-01	Yellow Flame Burner	•	•	•	•	1
	120786-02	Yellow Flame Burner	•	•	•	•	1
4	120517-03	Regulator Bracket	•	•	•	•	1
5	120630-05	ODS Pilot, NG	•	•	•	•	1
	120630-02	ODS Pilot, LP	•	•	•	•	1
6	098867-20	Gas Regulator, NG	•	•	•	•	1
	098867-21	Gas Regulator, LP	•	•	•	•	1
7	122142-01	Manual Valve with Ignitor, NG	•	•	•	•	1
	122142-02	Manual Valve with Ignitor, LP	•	•	•	•	1
8	123483-01	Inlet Tube Assembly	•	•	•	•	1
	122484-01	Burner Inlet Tube	•	•	•	•	1
9	099056-26	Orifice 0.1070	•	•	•	•	1
	099056-19	Orifice 0.0670	•	•	•	•	1
10	099387-08	Pilot Tube	•	•	•	•	1
11	098249-01	ODS Nut	•	•	•	•	2
12	M11084-38	Screw, HWH AB 8-18 x 0.38	•	•	•	•	2
13	M11084-26	Screw, HWH AB 10-16 x 0.38	•	•	•	•	7
14	098354-01	Control Knob	•	•	•	•	1
15	124532-01	18" Log Set	•	•	•	•	1
	124532-02	24" Log Set	•	•	•	•	1
15a	124673-01	Front Log	•	•	•	•	1
	124674-01	Front Log	•	•	•	•	1
15b	124673-02	Center Log	•	•	•	•	1
	124674-02	Center Log	•	•	•	•	1
15c	124673-03	Rear Log	•	•	•	•	1
	124674-03	Rear Log	•	•	•	•	1
15d	124673-04	Left Crossover Log	•	•	•	•	1
	124674-04	Left Crossover Log	•	•	•	•	1
15e	124673-05	Center Crossover Log	•	•	•	•	1
	124674-05	Center Crossover Log	•	•	•	•	1
15f	124673-06	Right Front Crossover Log	•	•	•	•	1
	124674-06	Right Front Crossover Log	•	•	•	•	1
PARTS AVAILABLE — NOT SHOWN							
	100563-01	Warning Plate	•	•	•	•	1
	101055-08	Lighting Instructions Plate	•	•	•	•	1
	100639-01	Caution Decal	•	•	•	•	1
	101137-02	Hardware Kit	•	•	•	•	1
	GA6060	Lava Rock	•	•	•	•	1

** Not a field replaceable part.

SPECIFICATIONS

HD18PB, HD24PB

- Rating (Variable): 19,000/36,000 Btu/Hr
- Type Gas: Propane/LP
- Ignition: Piezo
- Pressure Manifold: 10.0" W.C.
- Inlet Gas Pressure (in. of water):
Maximum 14" W.C., Minimum* 11" W.C.

- Shipping Weight: 27 lbs.

* For input adjustment

HD18NB, HD24NB

- Rating (Variable): 19,000/36,000 Btu/Hr
- Type Gas : Natural Gas
- Ignition: Piezo
- Pressure Manifold: 4.5" W.C.

- Inlet Gas Pressure (in. of water):
Maximum 10.5" W.C., Minimum* 5" W.C.

- Shipping Weight: 29 lbs.

* For input adjustment

REPLACEMENT PARTS

Note: Use only original replacement parts.

This will protect your warranty coverage for parts replaced under warranty.

Contact authorized dealers of this product. If they can't supply original replacement part(s), call FMI PRODUCTS, LLC at 1-866-328-4537.

When calling, have ready

- your name
- your address
- model and serial numbers of your heater
- how heater was malfunctioning
- type of gas used (propane/LP or natural gas)
- purchase date

Usually, we will ask you to return the part to the factory.

TECHNICAL SERVICE

You may have further questions about installation, operation or troubleshooting. If so, contact FMI PRODUCTS, LLC at 1-866-328-4537. When calling please have your model and serial numbers of your heater ready.

You can also visit our web site at

www.fmiproducts.com.

SERVICE HINTS

When Gas Pressure Is Too Low

- pilot will not stay lit
- burners will have delayed ignition
- heater will not produce specified heat
- propane/LP gas supply may be low

You may feel your gas pressure is too low. If so, contact your local natural or propane/LP gas supplier.

ACCESSORIES

Purchase these accessories from your local dealer. If they can not supply these accessories, either contact your nearest Parts Central or call FMI PRODUCTS, LLC at 1-866-328-4537 for information. You can also write to the address listed on the back page of this manual.

DAMPER CLAMP - GA6080

For all models. Permanently opens chimney flue damper for vented operation.

LAVA ROCK - GA6060

For all models. Order when additional rock is desired.

CONTROL COVER KIT - CDABKA

PINE CONES - GA9650A

WARRANTY

KEEP THIS WARRANTY

Model (located on product or identification tag) _____

Serial No. (located on product or identification tag) _____

Date Purchased _____

Keep receipt for warranty verification.

FMI PRODUCTS, LLC LIMITED WARRANTIES

New Products

Standard Warranty: FMI PRODUCTS, LLC warrants this new product and any parts thereof to be free from defects in material and workmanship for a period of four (4) years from the date of first purchase from an authorized dealer provided the product has been installed, maintained and operated in accordance with FMI PRODUCTS, LLC's warnings and instructions.

For products purchased for commercial, industrial or rental usage, this warranty is limited to 90 days from the date of first purchase.

Factory Reconditioned Products

Limited Warranty: FMI PRODUCTS, LLC warrants factory reconditioned products and any parts thereof to be free from defects in material and workmanship for 30 days from the date of first purchase from an authorized dealer provided the product has been installed, maintained and operated in accordance with FMI PRODUCTS, LLC's warnings and instructions.

Terms Common to All Warranties

The following terms apply to all of the above warranties:

Always specify model number and serial number when contacting the manufacturer. To make a claim under this warranty the bill of sale or other proof of purchase must be presented.

This warranty is extended only to the original retail purchaser when purchased from an authorized dealer, and only when installed by a qualified installer in accordance with all local codes and instructions furnished with this product.

This warranty covers the cost of part(s) required to restore this product to proper operating condition and an allowance for labor when provided by a FMI PRODUCTS, LLC Authorized Service Center or a provider approved by FMI PRODUCTS, LLC. Warranty parts must be obtained through authorized dealers of this product and/or FMI PRODUCTS, LLC who will provide original factory replacement parts. Failure to use original factory replacement parts voids this warranty.

Travel, handling, transportation, diagnostic, material, labor and incidental costs associated with warranty repairs, unless expressly covered by this warranty, are not reimbursable under this warranty and are the responsibility of the owner.

Excluded from this warranty are products or parts that fail or become damaged due to misuse, accidents, improper installation, lack of proper maintenance, tampering, or alteration(s).

This is FMI PRODUCTS, LLC's exclusive warranty, and to the full extent allowed by law; this express warranty excludes any and all other warranties, express or implied, written or verbal and limits the duration of any and all implied warranties, including warranties of merchantability and fitness for a particular purpose to four (4) years on new products and 30 days on factory reconditioned products from the date of first purchase. FMI PRODUCTS, LLC makes no other warranties regarding this product.

FMI PRODUCTS, LLC's liability is limited to the purchase price of the product, and FMI PRODUCTS, LLC shall not be liable for any other damages whatsoever under any circumstances including indirect, incidental, or consequential damages.

Some states do not allow limitations on how long an implied warranty lasts or the exclusion or limitation of incidental or consequential damages, so the above limitation or exclusion may not apply to you.

This warranty gives you specific legal rights, and you may also have other rights which vary from state to state.

For information about this warranty contact:

FMI PRODUCTS, LLC
2701 S. Harbor Blvd.
Santa Ana, CA 92704
1-866-328-4537
www.fmiproducts.com

124531-01
Rev D
06/13